



basmat.com



THE CLICK ENTRANCE MATTING

Basmat®

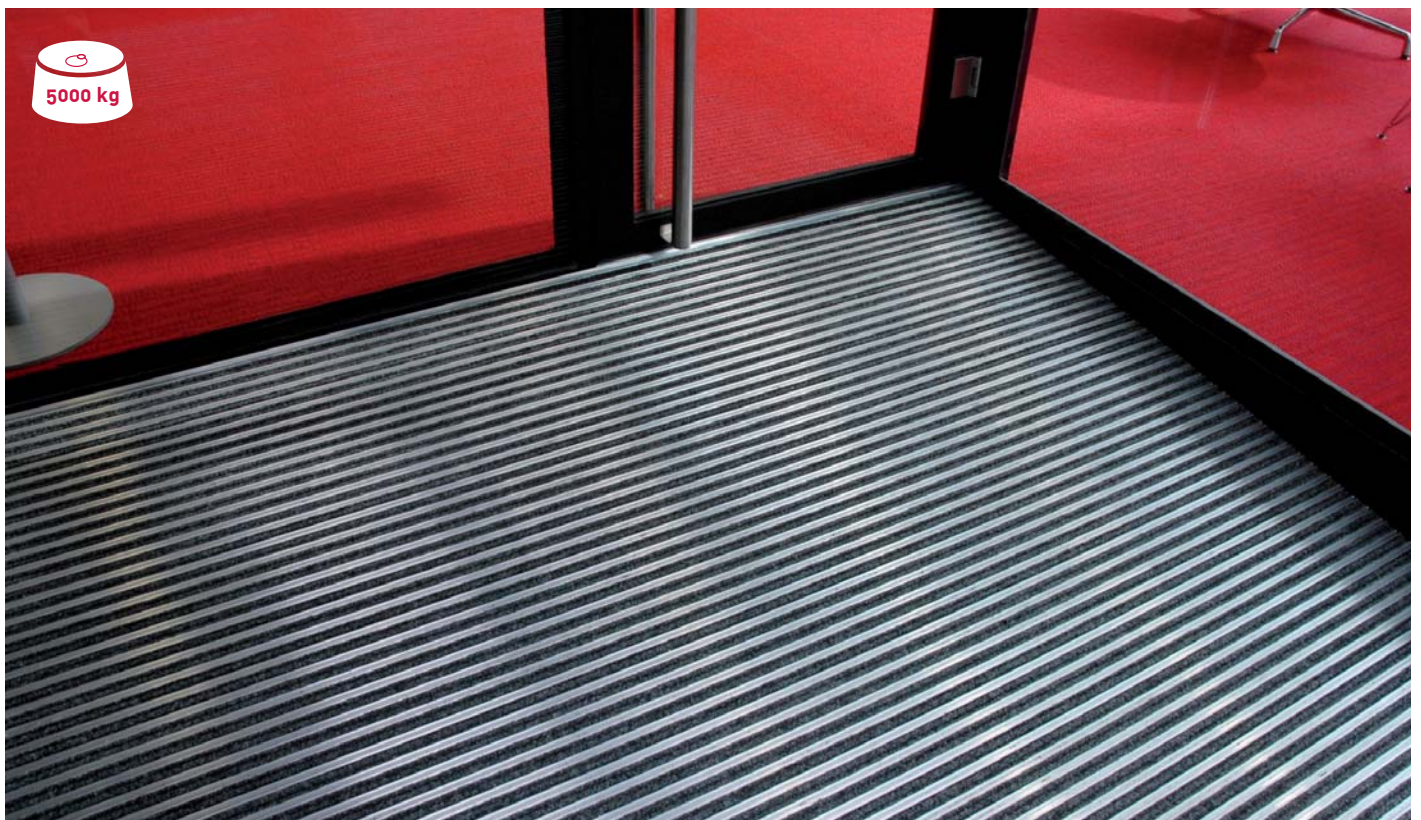

A company with more than 40 years of experience in the flooring market



BASMAT®

Basmat is the **leading** Spanish manufacturer of entrance matting systems. The headquarters, assembling plant and commercial management are located in Pamplona area, northern Spain.

Basmat is a company with the experience of more than **40 years** in the flooring sector.

Basmat is focused on the development of a **new concept** of entrance matting systems. Basmat mats are assembled thanks to its **unique patented click system**, adding numerous advantages that other similar products lack.

Basmat has its own R&D department, where it constantly **develops and improves** its products.

Basmat provides a quick and efficient supply, and a continuous adaptation to changing market demands.

Basmat products are marketed in many **sectors**: flooring, decoration, DIY, hardware stores, tile stores, hygiene, etc.

Basmat sells its products in the **5 continents**. The great success of the Basmat concept worldwide is the best proof of the **real innovation** and **exceptional performance** of its products.



INDEX

PAGE

2 Basmat

4 Basmat Atenea

6 Basmat Hermes

8 Basmat Apolo

10 Basmat Atenea + Ramps

12 Basmat Artemis

14 Basmat Cronos

16 Basmat New Zeus

18 Boxed Basmat

22 Manufacturing periods

23 Dirt, the source of problems

24 How does Basmat work?

25 Basmat advantages

27 Basmat and the competitors

28 Ecology

29 Specifying Basmat

30 Mobile app

31 Marketing

32 How to order / specify Basmat

33 Quotation / order form

34 FAQs

36 Basmat Atenea: Installation in a laminated floor

37 Installation tips

38 Accessories

39 Cleaning and maintenance

40 Basmat finishes

41 Polyamide mats

42 Warranty and technical information

44 Installation

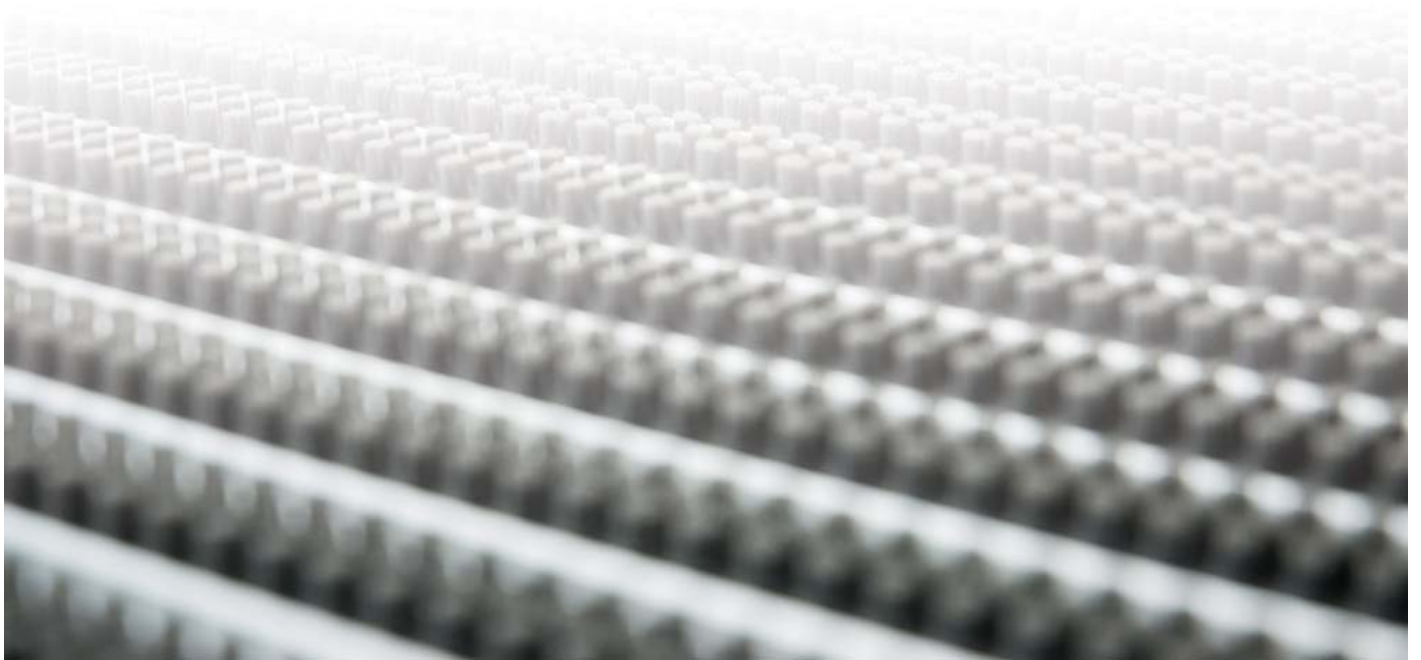

BASMAT ATENEA

THE MOST VERSATILE



**RECESSED
INSTALLATION**

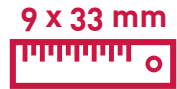

H 9 mm
W 33 mm

Textile

Rubber

Brushes

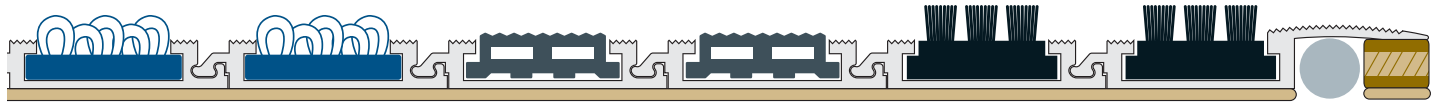

Height
9 mm.
Profile width
33 mm.
Profiles per linear metre
30 units.
Structure
100% aluminium. Anodised finish.
7 kg of aluminium per m².
Finish
Textile.
Isolation and consolidation
Polyethylene self-adhesive foam with fixing gauze.
Optional accessories
Lateral profiles and corner pieces.
Difficulty level
Low. 15 min/m².
Indicated for
Laminated floors and floors of all heights.
Maximum dimensions (1 unit)
Width: 3 m / no limits (staggered).
Length: No limits.

POLYPROPYLENE



POLYPROPYLENE - DIAMOND



Fire class - Smoke production
B fl - S1
Vertical load
50 KN (5,000 kg): Ok
Slip resistance
Class 3

Height
9 mm.
Profile width
33 mm.
Profiles per linear metre
30 units.
Structure
100% aluminium. Anodised finish.
7 kg of aluminium per m².
Finish
Rubber.
Isolation and consolidation
Polyethylene self-adhesive foam with fixing gauze.
Optional accessories
Lateral profiles and corner pieces.
Difficulty level
Low. 15 min/m².
Indicated for
Laminated floors and floors of all heights.
Maximum dimensions (1 unit)
Width: 3 m / no limits (staggered).
Length: No limits.



Fire class - Smoke production
D fl - S1
Vertical load
50 KN (5,000 kg): Ok
Slip resistance
Class 3

Height
9 mm.
Profile width
33 mm.
Profiles per linear metre
30 units.
Structure
100% aluminium. Anodised finish.
7 kg of aluminium per m².
Finish
Brushes.
Isolation and consolidation
Polyethylene self-adhesive foam with fixing gauze.
Optional accessories
Lateral profiles and corner pieces.
Difficulty level
Low. 15 min/m².
Indicated for
Laminated floors and floors of all heights.
Maximum dimensions (1 unit)
Width: 3 m / no limits (staggered).
Length: No limits.

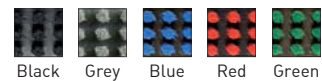

Fire class - Smoke production
B fl - S1
Vertical load
50 KN (5,000 kg): Ok
Slip resistance
Class 3

- Suitable for laminated floors, without building work.
- Easy to install.
- The budget and versatile option.
- Unlimited width (staggered), with unlimited length.



BASMAT HERMES



THE ORIGINAL
BASMAT

**RECESSED
INSTALLATION**

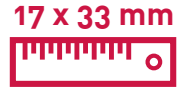

Textile

Rubber

Brushes

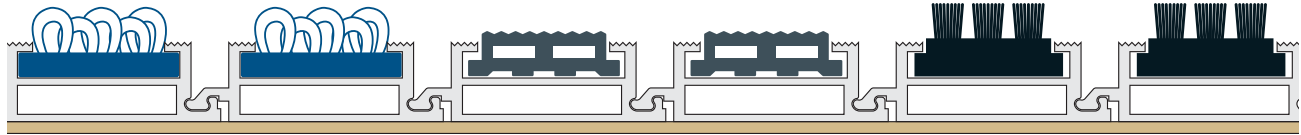

Height

17 mm.

Profile width

33 mm.

Profiles per linear metre

30 units.

Structure

100% aluminium. Anodised finish.
10 kg of aluminium per m².

Finish

Textile.

Isolation and consolidation

Polyethylene self-adhesive foam with fixing gauze.

Optional accessories

Lateral profiles and corner pieces.

Difficulty level

Low. 15 min/m².

Indicated for

Recessed installation.

Maximum dimensions (1 unit)

Width: 3 m / no limits (staggered).
Length: No limits.

POLYPROPYLENE



Black Blue Beige Red Camel



Grey Brown Green

POLYPROPYLENE - DIAMOND



Black

Fire class - Smoke production

B fl - S1

Vertical load

50 KN (5,000 kg): Ok

Slip resistance

Class 3

Height

17 mm.

Profile width

33 mm.

Profiles per linear metre

30 units.

Structure

100% aluminium. Anodised finish.
10 kg of aluminium per m².

Finish

Rubber.

Isolation and consolidation

Polyethylene self-adhesive foam with fixing gauze.

Optional accessories

Lateral profiles and corner pieces.

Difficulty level

Low. 15 min/m².

Indicated for

Recessed installation.

Maximum dimensions (1 unit)

Width: 3 m / no limits (staggered).
Length: No limits.



Black Photoluminescent

Height

17 mm.

Profile width

33 mm.

Profiles per linear metre

30 units.

Structure

100% aluminium. Anodised finish.
10 kg of aluminium per m².

Finish

Brushes.

Isolation and consolidation

Polyethylene self-adhesive foam with fixing gauze.

Optional accessories

Lateral profiles and corner pieces.

Difficulty level

Low. 15 min/m².

Indicated for

Recessed installation.

Maximum dimensions (1 unit)

Width: 3 m / no limits (staggered).
Length: No limits.



Black Grey Blue Red Green

Fire class - Smoke production

B fl - S1

Vertical load

50 KN (5,000 kg): Ok

Slip resistance

Class 3

- The standard model.
- Easy to install.
- Unlimited width (staggered), with unlimited length.

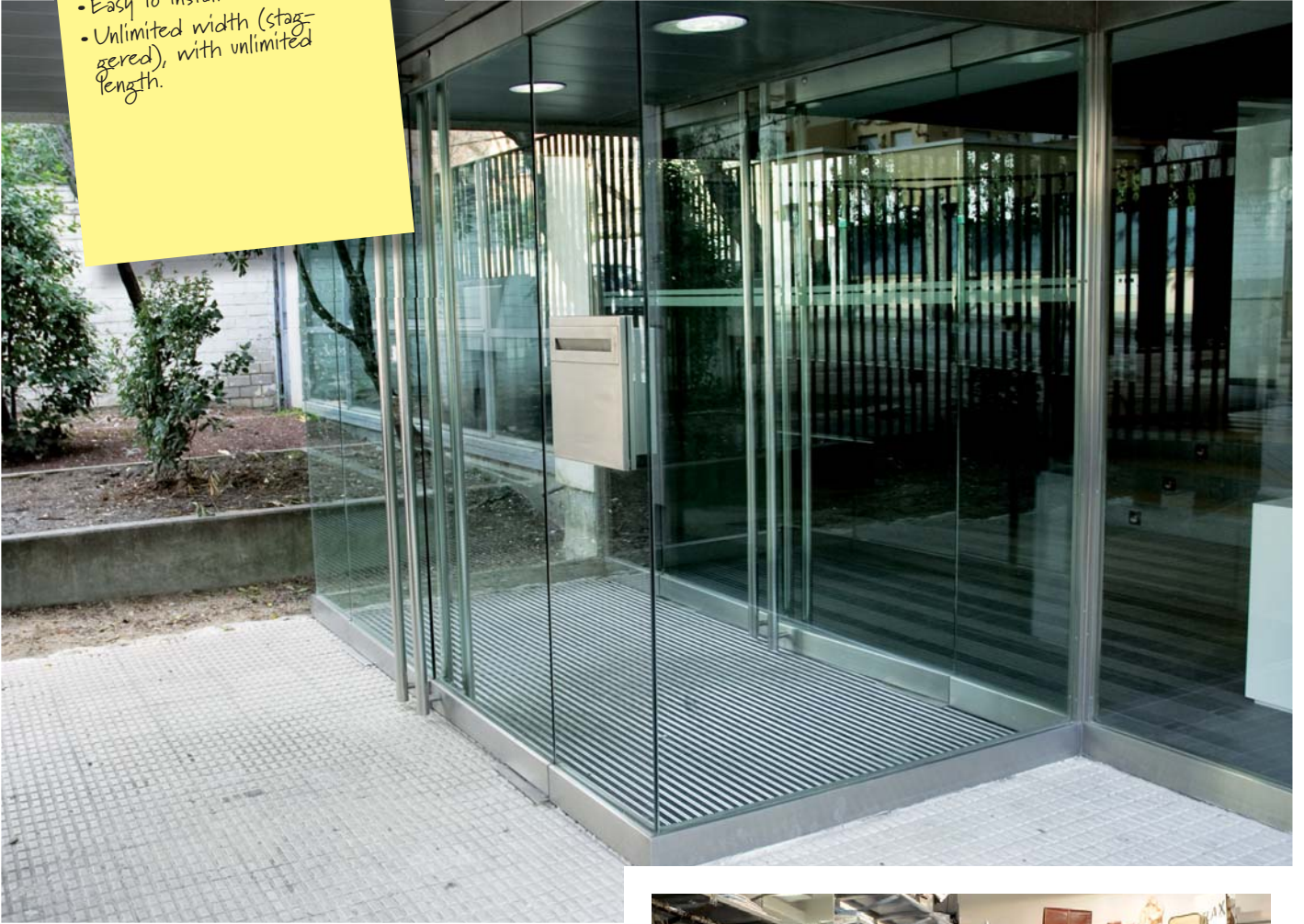

BASMAT APOLO

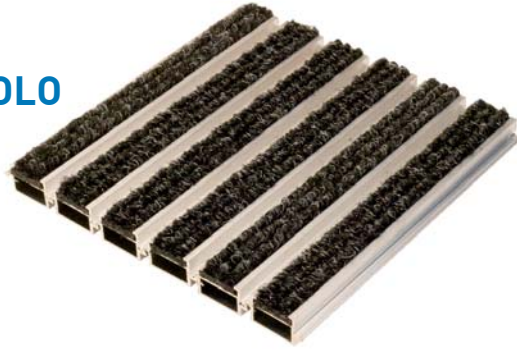

FOR THICKER FLOORS

RECESSED INSTALLATION

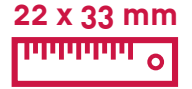

Textile

Rubber

Brushes

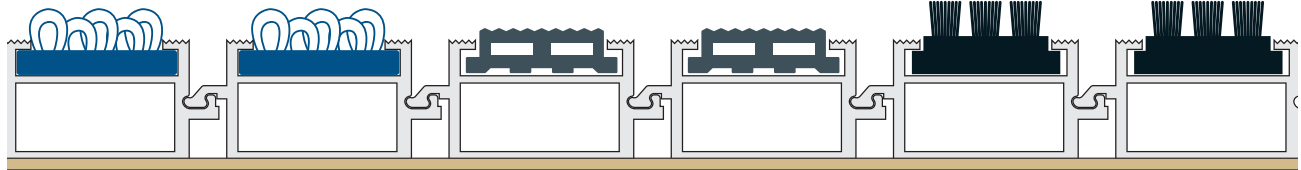

Height

22 mm.

Profile width

33 mm.

Profiles per linear metre

30 units.

Structure

100% aluminium. Anodised finish.
12,2 kg of aluminium per m².

Finish

Textile.

Isolation and consolidation

Polyethylene self-adhesive foam with fixing gauze.

Optional accessories

Lateral profiles and corner pieces.

Difficulty level

Low. 15 min/m².

Indicated for

Recessed installation.

Maximum dimensions (1 unit)

Width: 3 m / no limits (staggered).
Length: No limits.

POLYPROPYLENE



Black Blue Beige Red Camel



Grey Brown Green

POLYPROPYLENE - DIAMOND



Black

Fire class - Smoke production

B fl - S1

Vertical load

50 KN (5,000 kg): Ok

Slip resistance

Class 3

Height

22 mm.

Profile width

33 mm.

Profiles per linear metre

30 units.

Structure

100% aluminium. Anodised finish.
12,2 kg of aluminium per m².

Finish

Rubber.

Isolation and consolidation

Polyethylene self-adhesive foam with fixing gauze.

Optional accessories

Lateral profiles and corner pieces.

Difficulty level

Low. 15 min/m².

Indicated for

Recessed installation.

Maximum dimensions (1 unit)

Width: 3 m / no limits (staggered).
Length: No limits.



Black Photoluminescent

Fire class - Smoke production

D fl - S1

Vertical load

50 KN (5,000 kg): Ok

Slip resistance

Class 3

Height

22 mm.

Profile width

33 mm.

Profiles per linear metre

30 units.

Structure

100% aluminium. Anodised finish.
12,2 kg of aluminium per m².

Finish

Brushes.

Isolation and consolidation

Polyethylene self-adhesive foam with fixing gauze.

Optional accessories

Lateral profiles and corner pieces.

Difficulty level

Low. 15 min/m².

Indicated for

Recessed installation.

Maximum dimensions (1 unit)

Width: 3 m / no limits (staggered).
Length: No limits.



Black Grey Blue Red Green

Fire class - Smoke production

B fl - S1

Vertical load

50 KN (5,000 kg): Ok

Slip resistance

Class 3

H 22 mm
W 33 mm

- Suitable for marble or granite floors.
- Easy to install.
- Unlimited width (staggered), with unlimited length.

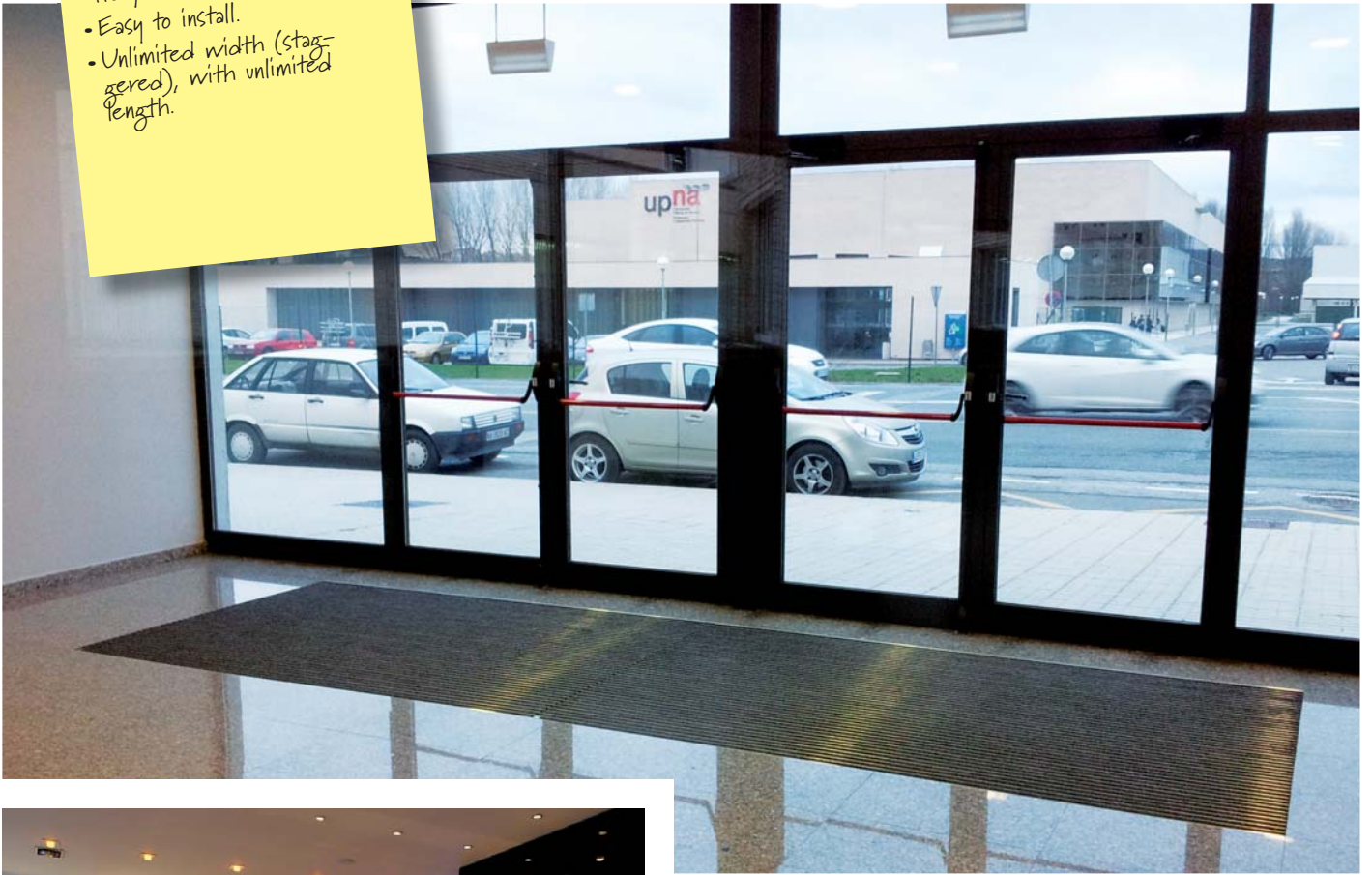

BASMAT ATENEA+RAMPS



NO MAT WELL NECESSARY

SURFACE INSTALLATION

9 x 33 mm



Textile Ramps

Rubber Ramps

Brushes Ramps

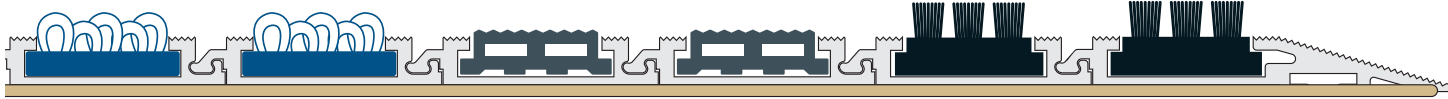

Height

9 mm.

Profile width

33 mm.

Profiles per linear metre

30 units.

Structure

100% aluminium. Anodised finish.
7,3 kg of aluminium per m².

Finish

Textile.

Isolation and consolidation

Anti-slip self-adhesive rubber with fixing gauze.

Included accessories

Ramps and corner pieces.

Difficulty level

Low. 15 min/m².

Indicated for

Floors where there is no mat well.

Maximum dimensions (1 unit)

Width: 3 m / no limits (staggered).
Length: No limits.

Height

9 mm.

Profile width

33 mm.

Profiles per linear metre

30 units.

Structure

100% aluminium. Anodised finish.
7,3 kg of aluminium per m².

Finish

Rubber.

Isolation and consolidation

Anti-slip self-adhesive rubber with fixing gauze.

Included accessories

Ramps and corner pieces.

Difficulty level

Low. 15 min/m².

Indicated for

Floors where there is no mat well.

Maximum dimensions (1 unit)

Width: 3 m / no limits (staggered).
Length: No limits.

Height

9 mm.

Profile width

33 mm.

Profiles per linear metre

30 units.

Structure

100% aluminium. Anodised finish.
7,3 kg of aluminium per m².

Finish

Brushes.

Isolation and consolidation

Anti-slip self-adhesive rubber with fixing gauze.

Included accessories

Ramps and corner pieces.

Difficulty level

Low. 15 min/m².

Indicated for

Floors where there is no mat well.

Maximum dimensions (1 unit)

Width: 3 m / no limits (staggered).
Length: No limits.

POLYPROPYLENE

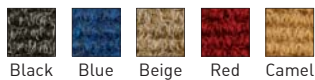

Black Blue Beige Red Camel



Grey Brown Green

POLYPROPYLENE - DIAMOND



Black



Black Photoluminescent



Black Grey Blue Red Green

Fire class - Smoke production

B fl - S1

Vertical load

50 KN (5,000 kg): Ok

Slip resistance

Class 3

Fire class - Smoke production

D fl - S1

Vertical load

50 KN (5,000 kg): Ok

Slip resistance

Class 3

Fire class - Smoke production

B fl - S1

Vertical load

50 KN (5,000 kg): Ok

Slip resistance

Class 3

H 9 mm
W 33 mm



ASSEMBLY

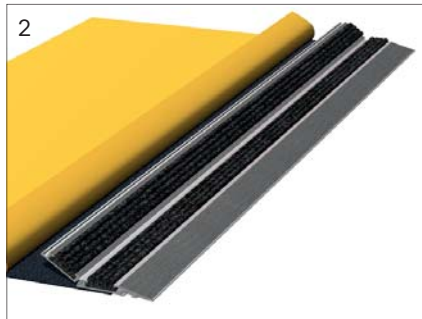
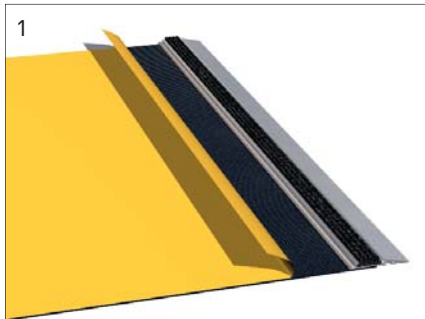

For large surface mats it is recommended to fix them to the flooring by means of screws.

BASMAT ARTEMIS



SPECIAL
WIDTH

**RECESSED
INSTALLATION**

Textile

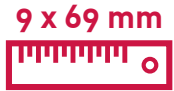

Height

9 mm.

Profile width

69 mm.

Profiles per linear metre

14 units.

Structure

100% aluminium. Anodised finish.

5,5 kg of aluminium per m².

Finish

Textile.

Isolation and consolidation

Polyethylene self-adhesive foam with fixing gauze.

Optional accessories

Lateral profiles and corner pieces.

Difficulty level

Very low. 10 min/m².

Indicated for

Laminated floors and floors of all heights. Large installations.

Maximum dimensions (1 unit)

Width: 3 m / no limits (staggered).

Length: No limits.

POLYPROPYLENE



Black Blue Beige Red Camel



Grey Brown Green

POLYPROPYLENE - DIAMOND



Black

Fire class - Smoke production

B fl - S1

Vertical load

50 KN (5,000 kg): Ok

Slip resistance

Class 3

H 9 mm
W 69 mm

- Less aluminium in sight: wider profiles.
- Special to cover large surfaces.
- Very easy to install.
- Unlimited width (staggered), with unlimited length.



BASMAT CRONOS

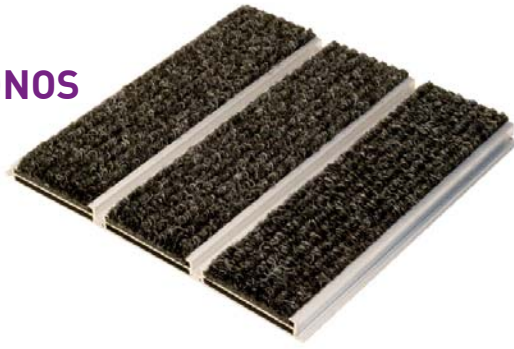

SPECIAL
WIDTH

**RECESSED
INSTALLATION**

Textile

17 x 69 mm

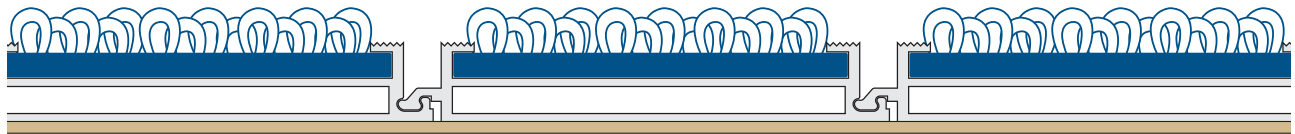

- Height**
17 mm.
- Profile width**
69 mm.
- Profiles per linear metre**
14 units.
- Structure**
100% aluminium. Anodised finish.
8,8 kg of aluminium per m².
- Finish**
Textile.
- Isolation and consolidation**
Polyethylene self-adhesive foam with fixing gauze.
- Optional accessories**
Lateral profiles and corner pieces.
- Difficulty level**
Very low. 10 min/m².
- Indicated for**
Recessed installation. Large installations.
- Maximum dimensions (1 unit)**
Width: 3 m / no limits (staggered).
Length: No limits.

POLYPROPYLENE



POLYPROPYLENE - DIAMOND



- Fire class - Smoke production**
B fl - S1
- Vertical load**
50 KN (5,000 kg): Ok
- Slip resistance**
Class 3

H 17 mm
W 69 mm

- Less aluminium in sight: wider profiles.
- Special to cover large surfaces.
- Very easy to install.
- Unlimited width (staggered), with unlimited length.



BASMAT NEW ZEUS



CONTINUOUS
STRUCTURE

**RECESSED
INSTALLATION**

17 x 93 mm

Textile

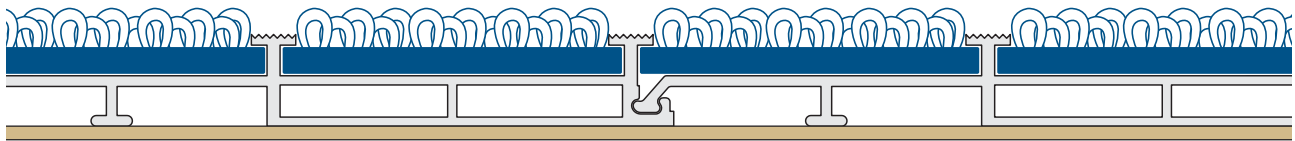

- Height**
17 mm.
- Profile width**
93 mm.
- Profiles per linear metre**
14 units.
- Structure**
100% aluminium. Anodised finish.
7,35 kg of aluminium per m².
- Finish**
Textile.
- Isolation and consolidation**
Polyethylene self-adhesive foam
with fixing gauze.
- Optional accessories**
Lateral profiles and corner pieces.
- Difficulty level**
Medium. 20 min/m².
- Indicated for**
Recessed installation.
- Maximum dimensions**
Width: 3 m / no limits (staggered).
Length: No limits.

POLYPROPYLENE



POLYPROPYLENE - DIAMOND



- Fire class - Smoke production**
B fl - S1
- Vertical load**
50 KN (5,000 kg): Ok
- Slip resistance**
Class 3

H 17 mm
W 93 mm



**BOXED BASMAT
(BASMAT ATENEA)**



9 x 33 mm



**UNLIMITED
DESIGN**

Textile

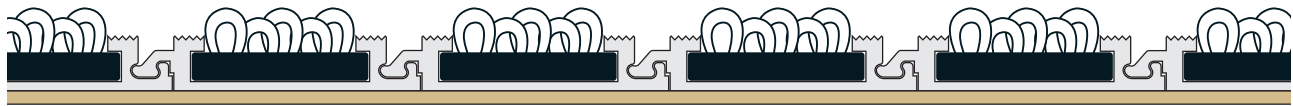

Height

9 mm.

Profile width

33 mm.

Profiles per linear metre

30 units.

Structure

100% aluminium. Anodised finish.

7 kg of aluminium per m².

Finish

Textile.

Isolation and consolidation

Polyethylene self-adhesive foam with fixing gauze (not included).

Optional accessories

Lateral profiles and corner pieces.

Difficulty level

Low. 15 min/m².

Indicated for

Laminated floors and floors of all heights.

Maximum dimensions (1 unit)

Width: 1,10 m / no limits (staggered).

Length: No limits.

Content of the box

14 units of 1100 mm

Total surface

0,5 m²

Fire class - Smoke production

B fl - S1

Vertical load

50 KN (5,000 kg): Ok

Slip resistance

Class 3

POLYPROPYLENE



Black

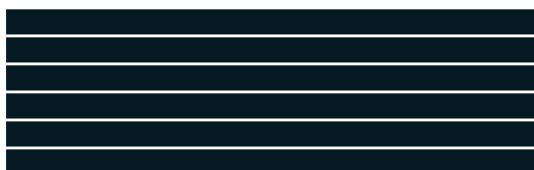

- 1 Mats of 1100 mm wide or less**
 You can install mats **narrower than 1100 mm** by cutting the profiles.

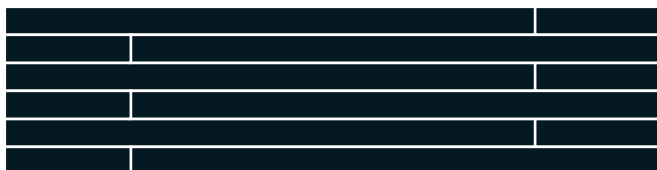

- 2 Mats of more than 1100 mm wide**
 You can install mats **wider than 1100 mm** by adding pieces. We recommend to install the profiles staggered to make the joints invisible.

Tips for cutting the profiles

- Mark before cutting: Always make some kind of mark on the aluminium before you begin cutting. This is the best way to prevent mistakes.
- Always use protective glasses.
- You can use a manual saw or a chop saw, suitable for aluminium.
- More information on www.basmat.com.

Necessary elements (not included in the box)

- Self-adhesive foam.
- Initial and final profiles.





MANUFACTURING PERIODS



YOU CAN HAVE YOUR OWN STOCK OF BASMAT PROFILES

Suitable for clients that want to provide an immediate service

You can have your own stock of Basmat profiles and prepare a made to measure mat in **minutes**. You only need to have a saw for aluminium. Thanks to this option, dozens of clients **worldwide** take advantage of the Basmat patented click system. Basmat can advise you about the most suitable **stock** for your area. This is a good option for customers in **distant** locations or countries with transport difficulties.

You can have a safety stock with the best seller references and use the **standard** or **express** services for momentary cases.



EXPRESS SERVICE

Urgent made to measure mats

Basmat is aware of the **urgencies** related to the installation of its products. Often, the mat is the last element to be installed in a building work, and it becomes, moreover, **essential** at the moment of the **opening**. That is why Basmat offers to its **regular clients** the Express service, reducing the manufacturing period to 24 hours. Please consult the conditions for this service.

(*) The period of 24 hours is the manufacturing period starting from the confirmation of the order.



STANDARD SERVICE

Made to measure mats

Basmat has **reduced** to the minimum the manufacturing period for better responding to the demands of the clients.

You can also use this service as an **added feature** to the purchase of Basmat bars by bulk. This way, it is not necessary to have a big **stock** of models, finishes and colours.

DIRT, THE SOURCE OF PROBLEMS



In places with heavy people traffic the dirt is the origin of **many problems**.

Research studies have discovered that **80%** of dirt introduced into a building is transported on the shoes of people walking into it.

First impressions are vitally important in business. A clean, dry and safe floor creates a very good first impression. This is important on all kinds of floorings: carpet, laminated, parquet, vinyl, marble, granite or ceramic. Wet and dry particles are deposited on the surface and due to their colour they cause a high contrast producing an **unsightly effect**.

Flooring with no absorption capacity has an additional problem. Moisture is introduced into the building generating **water deposits** on the floor. This moisture is progressively extended to all the premises. This produces a very negative impression and could be the trigger of **accidents** due to slipping.

Particles swept in by shoes have a very **abrasive** capacity and cause severe wear and tear on floors. Using Basmat your floors will be cleaner, you will use less harsh abrasive chemical detergents, prolonging the life of your floor and reducing the consumption of **aggressive** and **pollutant** products.

Flooring manufacturers recommend the installations of mats in order to **protect** your floors. The cleaning costs of a building are enormous and this will be reduced if you can keep 80% of the dirt outside the building.

The installation of Basmat, the click entrance matting, is the **perfect solution** to all these problems.

Basmat also contributes to preserving the **environment** thanks to the decrease in consumption of water and cleaning products and by extending the life of the flooring.

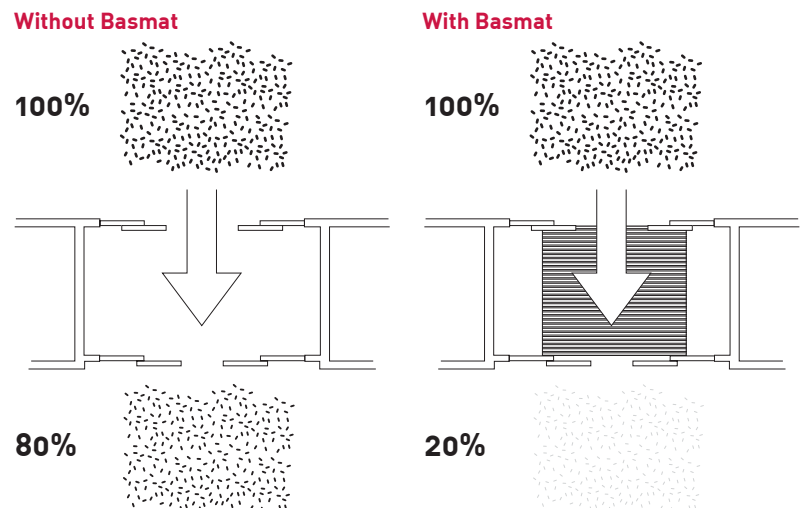

HOW DOES BASMAT WORK?

Basmat is an entrance mat composed of **aluminium profiles** with a carpet, brushes or rubber insert. The combined action of the different materials acts as a **dirt barrier** preserving the cleanliness of the buildings' flooring.

It is possible to choose from **several Basmat models** with various thicknesses.

In the mats with textile finishing the fluted aluminium scrapes and cleans the dirt transported by shoes and simultaneously the carpet **dries and retains** the dirt.

In the mats with rubber finish the action of the aluminium is complemented by the **irregularities** on the surface of the insert.

In the walk-off mats with brushes finishing, the shoes are cleaned by the **action of the bristles**.

Basmat **solves the limitations** of other kinds of matting that hardly meet the capability of removing, absorbing and retaining the dirt.



Thanks to the **unique patented click assembly system** the period between projection and installation is reduced to the minimum compared with similar products.

In contrast to other kinds of matting, walking over Basmat is very **comfortable and silent**. It has been designed to avoid problems with heels and it is suitable for wheeled traffic such as wheelchairs, babies' prams and pushchairs. Basmat can be also installed on a ramp.

Maintenance and cleaning is **very easy** by just using a vacuum cleaner. In contrast to other doormats, it is not necessary to **lift it up** to clean it.

Basmat also offers the possibility of **replacing the inserts** by just removing them from the profiles and inserting new ones.

<p>What is the most effective size?</p>	<p>(?)</p>
--	-------------------

In general, the **bigger** the mat is, the more dirt will be removed. **1,5 metres** of contact between the entrance mat and the soles of the shoes is enough to ensure a proper cleaning.

Thanks to its click assembly system, Basmat covers **bigger surfaces**. There are no limits in the dimension for the walking direction.

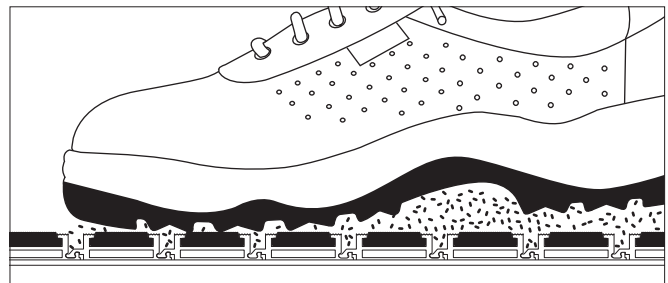
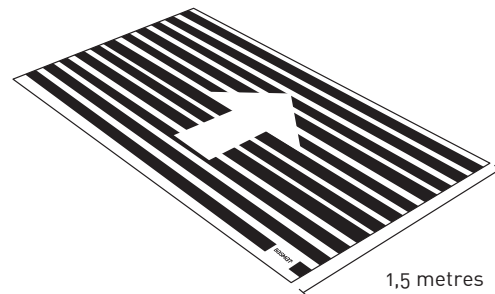

BASMAT ADVANTAGES

Basmat enhances the aesthetics of the entrance »»



Basmat can cover surfaces of any shape »»



AL

- Basmat is an entrance mat system composed of **aluminium profiles** and textile, rubber or brush inserts, with the choice of several colours. Basmat enhances the interior **aesthetics** of the entrance.



- The combination of different materials acts as a dirt barrier **preserving the cleanliness** of the buildings' flooring, saving money in maintenance costs.



- Basmat helps to increase the **durability of the floors**, and reduces the consumption of pollutant products that also damage the flooring.



- Basmat helps to **prevent accidents** due to slipping (slips and falls).



- Thanks to its unique click assembly system, the period between projection and installation is **reduced to the minimum** compared with similar products.



- Basmat can be installed **recessed or on a surface**. A range of accessories are available: ramps and framing profiles.



- Its system of assembly, without linking wires or connectors, **allows the cutting of profiles** on the site of installation, if necessary, and to make the appropriate adaptations.



- Basmat can be installed **anywhere**; from houses to public buildings, offices, hotels, restaurants, industrial facilities, banks or shops. It is suitable for heavy traffic and the harshest conditions.



- The profiles are inserted one into another by the unique click system, without using small pieces of connectors that could weaken the structure. As a result, Basmat is characterized by its great **resistance and durability**, thanks to its 100% aluminium structure.

Basmat finishing strips can be replaced easily »»



BASMAT ADVANTAGES

The click system is unique, simple and smart

Basmat is more than a mat, it is flooring



- Basmat is more than a mat, **it is flooring**. Thanks to its **unique, simple and smart** click assembly system, Basmat can be installed in places where it is **impossible** to place similar mats of other manufacturers; irregular forms, on ramps, between automatic doors, between glass or screens, underneath skirtings, in laminated floors, on stairs, etc. The system is protected in several countries by a **patent**.



- Basmat is specially conceived to cover **large surfaces**, without dividing the mat in smaller parts, in contrast to other similar products.



- In contrast to other aluminium mats, it is not necessary to **lift it up** in order to clean it, using a vacuum cleaner is enough.



- In case of deterioration, the textile, rubber or brush strips, can be **replaced** by removing them from the profiles and inserting new ones.



- **LEED points**. Installing Basmat you can get LEED points: IEQ Credit 5 (1 point). MR Credit 4 (1-2 points), MR Credit 5.1 and 5.2 (1-2 points).

Wear and tear of the flooring

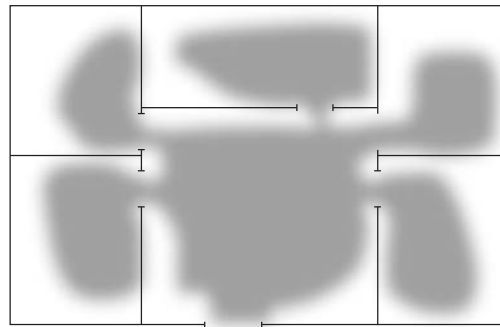

Without Basmat

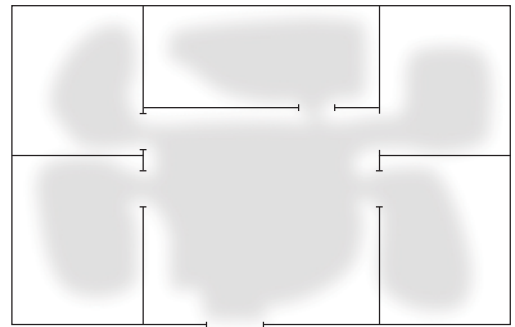

With Basmat



Maintenance and cleaning is very easy by just using a vacuum cleaner

100% aluminium structure

BASMAT AND THE COMPETITORS

	BASMAT	COMPETITORS
Surface limitations	<p>The click system has no surface limitations.</p> <p>It is possible to click and assemble an unlimited number of profiles on site.</p> <p>Huge aluminium mats can be made in a single unit.</p>	<p>The size is limited because it is prefabricated, also affecting the delivery and installation.</p>
Price competitiveness	<p>The simplicity of the click system reduces production costs without affecting the quality and resistance. It costs less to maintain.</p>	<p>The production and maintenance costs are higher (higher price).</p>
Production time	<p>The click system makes it possible to purchase and assemble the mat in less than 24 hours.</p>	<p>The product is prefabricated in a factory (delivery time is between 1 and 3 weeks).</p>
Adaptation to irregularities, obstacles and shapes	<p>The click system adapts to any obstacle, wrong measurement and shape on site by simply using an aluminium saw.</p> <p>Basmat can be installed in places where other mats cannot.</p> <p>There are several different types of profiles available, for any kind of problem.</p>	<p>Because the mat is prefabricated, it is less adaptable to obstacles, incorrect measurements and irregular shapes on site.</p> <p>In case of a wrong measurement has to be resent to the factory again.</p>
Resistance	<p>The aluminium click system structure allows Basmat mats to resist 5 tons of weight without breaking.</p> <p>100% quality guarantee.</p>	<p>Most others use cables and connectors, which weaken the structure and make the mat susceptible to weight limits.</p>
Cleaning	<p>Since the dirt does not pass underneath Basmat grooves, it is not necessary to lift the mat for proper cleaning.</p> <p>A vacuum cleaner is all that you need to thoroughly clean the mat.</p>	<p>Mats with holes allow dirt pass underneath, so they must be rolled up or pulled up for proper cleaning.</p> <p>The cleaning staff usually won't roll them up because they are so heavy.</p> <p>After a period of time, dirt accumulates in the holes making it look dirty and damaged.</p>
Reparation (If for some reason a profile becomes damaged, it can be easily repaired)	<p>The individual aluminium profiles can be changed easily. Simply dismantle the mat, take out the damaged profile and click in a new one. Less repairing costs and time.</p>	<p>The mat must be sent back to the factory to be repaired and then sent back to the customer.</p> <p>More expensive and a long waiting time.</p>
Possibility of stocking profiles	<p>The client can have a stock of profiles and, after cutting them, send the mats quickly to the end customer.</p>	<p>The mats are always ordered made to measure.</p>

ECOLOGY



The respect of the **environment** is a priority for Basmat. The industrial processes are designed to save energy and water. The **suppliers'** policy also takes into account the respect to the nature.



Basmat mats are made with varied degrees of renewable and **recycled** materials. All the materials that compose



Basmat mats are **recyclable**. Basmat wants to preserve clean air by avoiding the emission of greenhouse gases. Basmat is member of the **US Green Building Council**. Basmat entrance mats provide safer and cleaner floors and buildings. That is why you can get **LEED points** for your projects.

With Basmat you can get LEED points for your projects ”

LEED POINTS OBTAINABLE WITH BASMAT

IEQ Credit 5. LEED-NC v.3: For 1 point: permanently installed entrance system of at least 3 metres in length.

MR Credit 4: For 1-2 points. Economic value of all materials = min. average 10% recycled content. Basmat aluminium contains a 20% of recycled material.

MR Credit 5.1 and 5.2. 1-2 points if the materials have been manufactured in less than 800 km.

SPECIFYING BASMAT



Basmat makes my projects stand out ””

Why architects and interior designers prefer Basmat? (?)

Everyone wants to receive a **good impression** when entering a building. A beautiful and, at the same time, clean entrance can be a challenge for the architects and interior designers. Basmat is the solution to their **requirements** as it provides everything that the professionals demand: beautiful and clean entrances and safety for the public.

- Beauty: it gives a **distinguished** appearance to the entrance.
- Cleanliness: Basmat allows **keeping** the floors clean.
- Safety measures: it helps to **prevent** slips and falls.
- **Protection** of floors against damage and tear.
- Service: **Fast delivery**. Basmat can ship a mat in 24 hours. The mats are delivered dismantled reducing the packaging, storage and transport costs enormously.
- A large **range** of different models and finishes.
- Basmat means unlimited design. Basmat can be installed in places where it is **impossible** to place similar mats of other manufacturers; irregular forms, on ramps, between automatic doors, between glass or screens, underneath skirtings, in laminated floors, on stairs, etc.



- Basmat is specifically designed to cover **large surfaces**, without dividing the mat in smaller parts, in contrast to the competition products.

Do you want your projects to stand out? Please consult the section 'How to order / specify Basmat' or contact Basmat if you need any assistance.

MOBILE APP



Thanks to the mobile Basmat **app**, you can have your estimate in less than a minute. Please fill the data in the assistant (dimensions, finish, colour, etc.) Finally you will receive a document in doc or pdf format in the **provided e-mail** addresses.

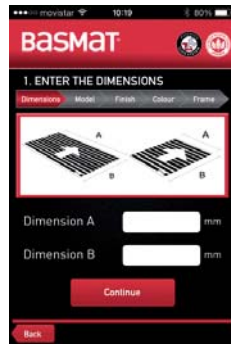

1. Enter the dimensions A and B.

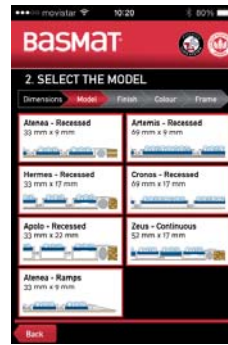

2. Select and confirm the model.



3. Select the finish.

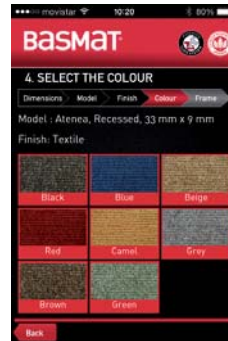

4. Select the colour.

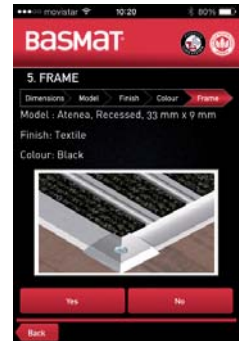

5. If you want, you can add the lateral profiles.



6. Get a simulated picture of Basmat in the place of installation.



7. Enter the e-mail addresses that will receive the estimate.



9. The recipients will receive a detailed estimate by e-mail in pdf or editable doc.

MARKETING

Metallic display stand

Ref. V800000015

Height 1900 mm
Width 490 mm
Depth 340 mm



Simple and practical display stand, made of steel. It incorporates **samples and information** of Basmat entrance matting.

Desktop display

Ref. MKT0000006

Height 280 mm
Width 210 mm
Depth 250 mm



Desktop display, made of cardboard. It can also be filed in a standard ring binder. It incorporates a **sample** of Basmat entrance matting.

Samples



Generic or by models Basmat **samples**.

Samples' box



HOW TO ORDER / SPECIFY BASMAT

How to order Basmat

1. Take the measurements

- Make sure that the surface where the mat is going to be installed is **flat and uniform**. Optionally, you can use self-levelling compound to flatten it.
- Take the measurements A and B inside the mat well.

2. Send the mat order or estimate request

Contact a Basmat dealer or send your mat order / request to basmat@basmat.com or fax it to (+34) 948 29 05 53. You can also enter the details on www.basmat.com.

If you want to receive an instant estimate by e-mail, you can use the Basmat mobile app. To confirm your order please resend it to a dealer or to Basmat by e-mail or fax.

Please indicate the desired model and finish.

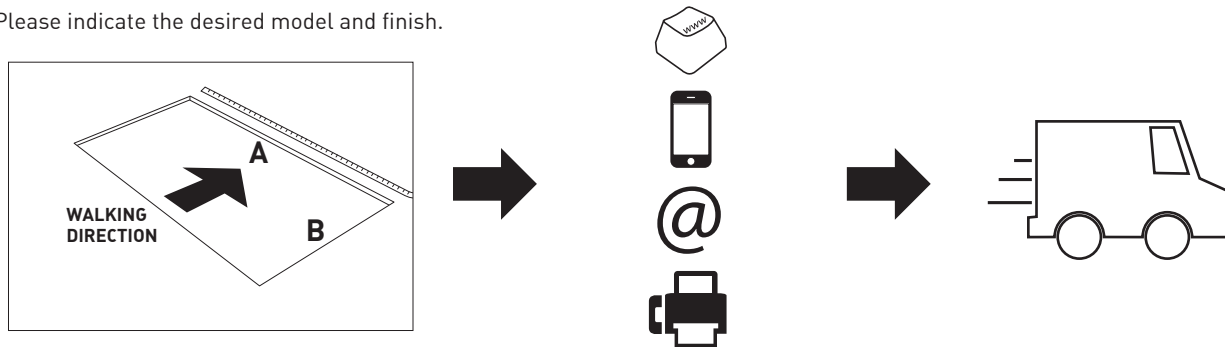

How to specify Basmat

If you want to **specify** Basmat in your projects, please use the following text (delete that which does not apply):

Basmat modular entrance mat, click system supplied by **Basmat**, phone (+34) 948 23 04 92, fax (+34) 948 29 05 53, E-mail: basmat@basmat.com.

Product to be installed per manufacturer's instructions.

Basmat (Atenea) / (Hermes) / (Apolo) / (Atenea+Ramps) / (Artemis) / (Cronos) / (New Zeus).

(Polypropylene textile: black / blue / beige / red / camel / grey / brown / green / black diamond) / (Rubber: black / photoluminescent) / (Brushes: black / grey / blue / red / green).

(With framing profiles) (Without framing profiles)

(A)..... x (B)..... mm

Please add a sketch or a blueprint of the mats.

Example:

**Basmat Atenea, Black textile, with framing profiles.
A: 1,570 mm
B: 1,180 mm**

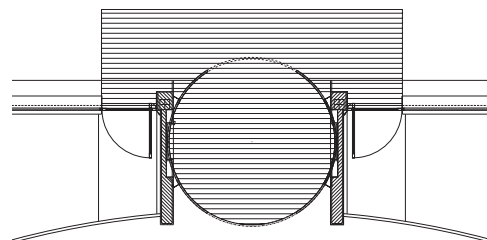

En18

Mat order / Quotation request

1. Tick the correct box, order or quote request. Choose the model, finish and colour of your entrance mat.

Order Quote request

Model	Polypropylene textile finish	Rubber finish	Brushes finish
<input type="checkbox"/> ATENEA Height: 9 mm <input type="checkbox"/> HERMES Height: 17 mm <input type="checkbox"/> APOLO Height: 22 mm <input type="checkbox"/> ATENEA+RAMPS Height: 9 mm <input type="checkbox"/> ARTEMIS Height: 9 mm <input type="checkbox"/> CRONOS Height: 17 mm <input type="checkbox"/> NEW ZEUS Height: 17 mm	<input type="checkbox"/> Black <input type="checkbox"/> Blue <input type="checkbox"/> Beige <input type="checkbox"/> Red <input type="checkbox"/> Camel <input type="checkbox"/> Grey <input type="checkbox"/> Brown <input type="checkbox"/> Green <input type="checkbox"/> Black (diamond)	<input type="checkbox"/> Black <input type="checkbox"/> Photoluminescent	<input type="checkbox"/> Black <input type="checkbox"/> Grey <input type="checkbox"/> Blue <input type="checkbox"/> Red <input type="checkbox"/> Green

2. Draw a sketch of your Basmat mat.

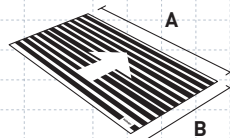
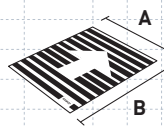
Dimension A: mm

Dimension B: mm

LATERAL PROFILES AND CORNER PIECES (Recessed models)

Yes No

Comments:

3. Fill your contact details and send by fax this page or a copy to (+34) 948 290 553. You can also send it by e-mail to basmat@basmat.com

Company: Contact: Phone:

Fax: Address: City:

Country: Postcode: E-mail:

FAQS

1. What's the biggest mat that I can install with Basmat?

There is no a maximum size, since we always can divide a mat in smaller parts. If we are talking about the size of a unit, the maximum width is 4,5 metres, with no limits in the walking direction.

2. I'm not an expert, how difficult is to install Basmat?

All of the models are easy to be installed. We provide the instructions and all the components required. If there is a particular shape, you only need to have a saw for aluminium to cut the profiles.



3. Can Basmat be installed by a single person?

Yes, but only if the mat is not wider than 2 metres.

4. Where do I have to stick the self-adhesive foam? To the floor?

The foam is not double sided. The adhesive part has to be stuck to the profiles. You must peel the protective paper as you are clicking the profiles one by one to keep all of them together and while you are pushing down the profiles.

5. Can I install Basmat on a surface, without a mat well?

Yes, for this purpose the most suitable model is Basmat Atenea+Ramps

6. Does Basmat offer different heights?

Yes, Basmat offers 3 different heights: 9, 17 and 22 mm.

7. Is there any model with less aluminium on sight?

Yes, the models Cronos and Artemis have a smaller proportion of aluminium than the rest of the models.

8. Can I change the carpet, rubber or brushes if they get damaged or old?

Yes, you can. You only have to remove the damaged strips and insert the new ones, adding some adhesive between the profile and the finish.



9. What is the manufacturing period of Basmat?

The ordinary average period is 3 working days counting from the order confirmation, but, in case of urgency, the mats can be manufactured in 1 working day. This information is not contractual. Basmat does not accept any liability for the delays in the manufacturing or delivery.

10. I would like to have a stock of Basmat bars, is that possible?

Yes, it is. For customers who want to provide an immediate service, Basmat offers the possibility of stocking profiles. This is a good option for customers in distant locations or countries with transport difficulties.



11. Can I install a frame around a Basmat mat?

Yes. Basmat provides the initial and final profiles which are part of the frame. You can also order the lateral profiles and corners to obtain the entire frame.

12. If the mat is installed outside, how can I avoid a theft?

We recommend screwing the mat down. Pull the finish up, drill the initial and final profiles, screw them down and put the finish back.

13. My mat has an irregular shape, how do I place the order?

Simply send a sketch by e-mail or fax to Basmat. A quotation will be sent to you with the elements needed.

14. Can I combine different finishes in a single mat?

Yes, a mat can have different finishes.

15. How can I clean Basmat?

Basmat can be cleaned with a vacuum cleaner. In the case of staining, you can use current cleaning products.

16. Is necessary to lift the mat to clean it?

It is not necessary, taking into account that the dirt is trapped in the aluminium grooves.

17. Before, I bought an aluminium mat whose steel wires broke, will the same thing occur with Basmat?

No, the Basmat structure is 100% aluminium, without cables or elements that could weaken the structure.

18. Why Basmat is so heavy?

Basmat structure is made of 100% high resistance aluminium.

19. Do you have samples or displays?

Yes, Basmat offers samples and 2 models of displays to show its products.

20. I want to install Basmat in a laminated floor, which model would you recommend?

Basmat Atenea and Artemis are especially designed to be installed recessed in laminated floors, without building work.

21. I want to install Basmat outside, which model would you recommend?

You can choose the model you want. If the mat is not protected we recommend the rubber or brushes finish. If the mat is partially protected you can also choose the textile finish.

22. Which model is more resistant?

The resistance of all the models is similar.



BASMAT ATENEA: INSTALLATION IN A LAMINATED FLOOR

Laminate floors are beautiful and resistant. In order to preserve their **unique features**, manufacturers recommend installing a doormat to keep them clean and dry. Atenea model is the perfect solution to protect their original beauty. It can be installed in a simple and easy way.

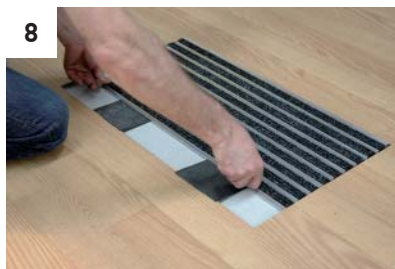
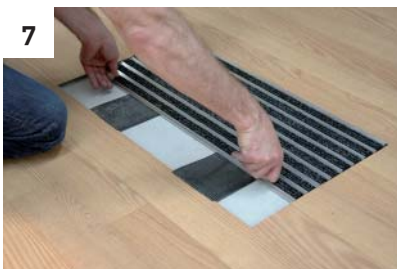
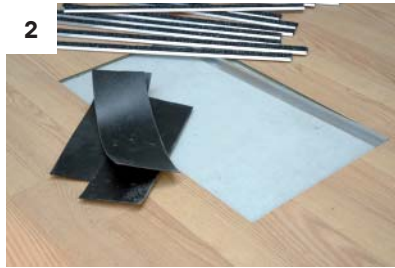

INSTALLATION TIPS

Packaging

All the materials that compose each Basmat entrance mat are sent in a tube or box.



Preparation of the mat well

(!) The surface where Basmat is going to be installed must be **flat and uniform**. Optionally, you can use self-levelling compound to flatten it.



Safety

If necessary Basmat can be **secured** by screwing it to the floor. Partially retire the carpet, antislip or brushes strips and drill the profile. Screw it in and cover the screws with the strips. It is recommended to glue the strips to the profiles.



ACCESSORIES

Accessories for recessing

Valid for all recessed models



Lateral profile for recessing.

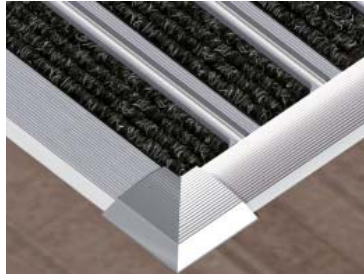

Corner piece to be glued.

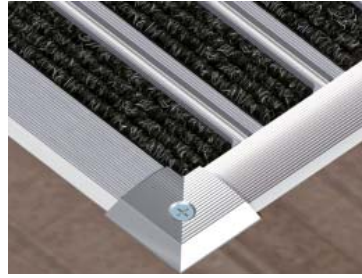

Corner piece to be screwed.

“J” profiles

For installations where it is not possible to install the initial and/or final profiles



Atenea and Artemis

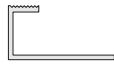

Hermes and Cronos

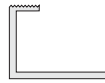

Apolo

Adjusting rubber band

Recessed installation



If desired, an adjusting band made of rubber is available to reach the dimension of the mat well.



Basmat Atenea and Artemis



Basmat Hermes and Cronos

Plastic bands for LED lighting



If you want to install a **lighted mat**, you can order our special translucent plastic strips. Inside you can place LED light bands (not supplied). The light can be connected directly to the current, to the emergency lighting or to a motion & presence detector.

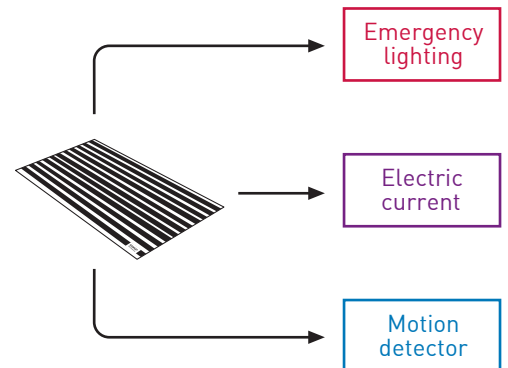

Stair nosing

Basmat Atenea and Artemis



Available in textile, rubber and brushes finish.

CLEANING AND MAINTENANCE

Basmat aluminium profiles are **anodised**, giving them a matt finish. This finish **protects** them against dirt and moisture.

It is not necessary to **lift up** the mat to clean it. Basmat must be cleaned with a **vacuum cleaner**. In the case of staining, normal cleaning products can be used. Basmat finishing strips can be replaced **easily**.

Similar products from other manufacturers must be **picked up or removed** to clean them, but this task is not made due to the weight and size of the mats. A surface cleaning is usually made and the **dirt stays in the mat well**.

Basmat helps to save **time** and **maintenance costs**.

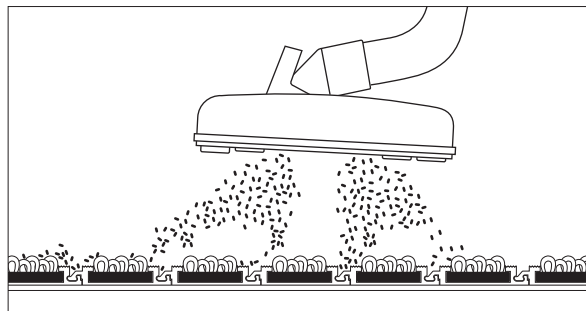
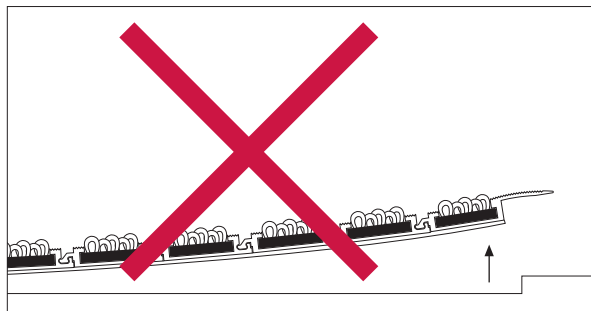

A dirty walk-off mat is the proof of its **capability** of trapping the dirt and moisture.

BASMAT FINISHES

The choice of the Basmat finish is determined on the **features** of the place of installation. All the available finishes are characterized by their great resistance to humidity and wear and tear.

Textile finish



The polypropylene textile finish is the standard one, with more than 90% of the sales. It shows a great resistance against wear and tear and retire vigorously the dirt from the shoes. The maintenance is simple because it does not get dirty easily. It is not recommended to install it outdoors if it is not partially protected by a porch or an eave: it can be unpleasant to step on a splashing mat.



Rubber finish

The rubber finish is the most suitable one for an outdoor installation.

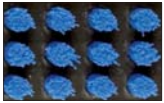









Brushes' finish

The brushes' finish is suitable for an outdoor installation. It is also a good option to retire snow remains from the shoes. It is useful to isolate dusty spaces from cleaner ones.

POLYAMIDE MATS

High quality polyamide doormats with a plastic base.



DIMENSIONS	REFERENCE	COLOUR	DESCRIPTION
60x80 cm	K2001	Black	Polyamide Basmat mat 
	K2002	Grey	Polyamide Basmat mat 
	K2003	Bordeaux	Polyamide Basmat mat 
60x180 cm	K2004	Black	Polyamide Basmat mat 
	K2005	Grey	Polyamide Basmat mat 
	K2006	Bordeaux	Polyamide Basmat mat 
80x120 cm	K2007	Black	Polyamide Basmat mat 
	K2008	Grey	Polyamide Basmat mat 
	K2009	Bordeaux	Polyamide Basmat mat 

Technical details

Manufacturing process	ISO 2424	Tufted
Surface aspect		1/8" C
Pile yarn composition		100% PA ₆
Backing	ISO 2424	PVC
Pile weight		520 g/m ² ± 7,5%
Total weight	ISO 8543	2820 g/m ² ± 7,5%
Pile height		3,0 mm ± 0,5
Total height	ISO 1766	6,0 mm ± 7,5%

WARRANTY AND TECHNICAL INFORMATION

Warranty

Basmat warrants for 10 years the aluminium structure of Basmat entrance matting systems. The guarantee for the textile and rubber inserts is 2 years. This warranty includes all defects which, demonstrably, are due to manufacturing defects or material.

Exclusions

This warranty does not cover normal wear of the profiles or finishes.

Basmat will not be liable for damages under the following circumstances:

- Misuse or abuse.
- Faulty or negligent handling.
- Failure to comply with instructions for assembly and maintenance, modifications or repairs without authorization of Basmat.
- Chemical and physical reactions on the surface of the materials produced by an improper use.

Conditions of the guarantee

Basmat will repair for free or replace the product for the first end user. Costs, postage and other expenses incurred by the holder of the warranty will not be paid. The warranty will be effective presenting the product and the sale invoice.

Technical information

ALUMINIUM

Alloy 6063 T5, according to the norm UNE 38-337-01. Anodised finish.

Mechanical features (T5)

Load of rupture 160 N/mm².

Elastic limit 110 N/mm².

Lengthening 7%.

POLYPROPYLENE CARPET

Manufacturing process: Needlepunch.

Pile content: 100% polypropylene.

Second backing: Eco Di Back.

Pile weight: 1200 gr/m².

Total weight: 2630 gr/m².

Pile height: 5 mm.

Total height: 6.4 mm.

Original width: 4 m.

Available colours: Black, blue, beige, red, camel, grey, brown and green.

ANTISLIP

Rubber or photoluminescent elastomer.

BRUSHES

Fiber material: Polyamide PA6

Body material: Polyvinylchlorid PVC

Punching wire: V2A

SELF-ADHESIVE FOAM

Self-adhesive high density polyethylene foam.

Thickness: 2 mm.

Original width: 120 mm.

FIRE TEST

Fire reaction test. Tested and classified according to the requirements of the norm UNE-EN 13501-1:07+A1:2010.

Testing methods: UNE-EN ISO 9239-1:11.
UNE-EN ISO 11925-2:11.

	Fire class	Smoke production
Polypropylene textile finish	B fl	S1
Brushes finish	B fl	S1
Rubber finish / ABS	D fl	S1

RESISTANCE TO VERTICAL LOAD

50 KN (5000 kg): Ok

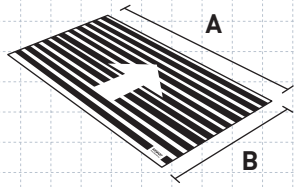

A: mm

B: mm

(!)



The surface where Basmat is going to be installed must be **flat and uniform**. Optionally, you can use self-levelling compound to flatten it.

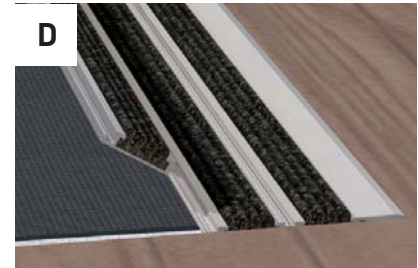
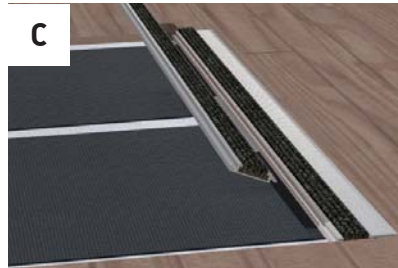
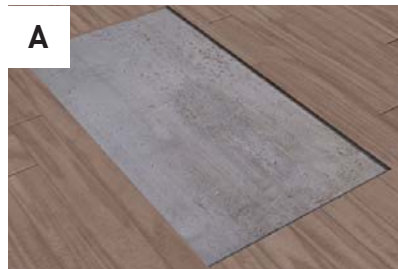

INSTALLER
QUOTE:

It was the easiest
mat I ever installed

EASY INSTALLATION PATENTED CLICK SYSTEM

ASSEMBLY DIRECTIONS

1. Clean and prepare the surface where **Basmat** is going to be placed.
2. Place the self-adhesive black foam strips parallel to each other with the adhesive part facing upwards. Peel off the protective paper a few centimetres.
3. Place the first **Basmat** profile.
4. Keep placing the **Basmat** profiles clicking one into the next one and sticking them down to the black foam.
5. Keep peeling the protective paper as you are adding more profiles.
6. Continue the assembly process until the last bar. Cut the spare self-adhesive foam. Adjust **Basmat** to the available space.



MOBILE APP



VIDEOS, PHOTOS AND DOWNLOADS



www.basmat.com



Basmat®

Pol. Comarca I, C/M 17
31160 Orcoyen. Navarre. Spain
Tel. [+34] 948 23 04 92
Fax [+34] 948 29 05 53
basmat@basmat.com
www.basmat.com